

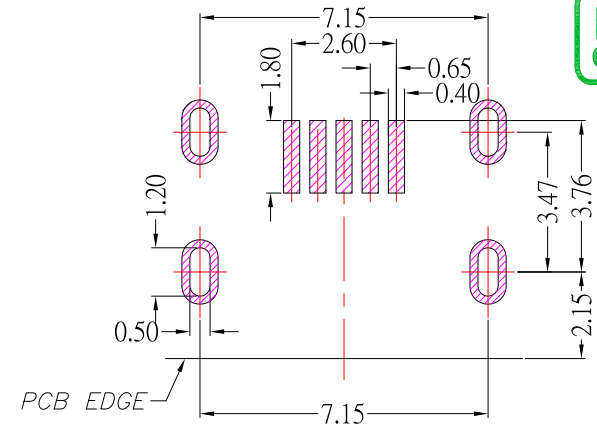

# MRUSB-5B-D17xx-S347

Shell Material : SHELL 鍍層:

|               |    |
|---------------|----|
| Blank : BRASS | TN |
| A : SUS       | NI |

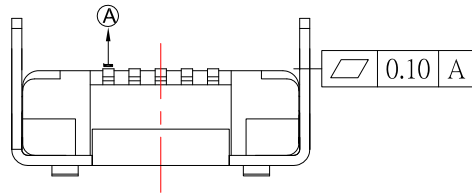

P.C.B LAYOUT MOUNTING PATTERN

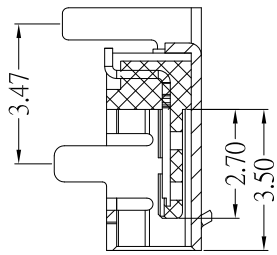

SECTION A-A

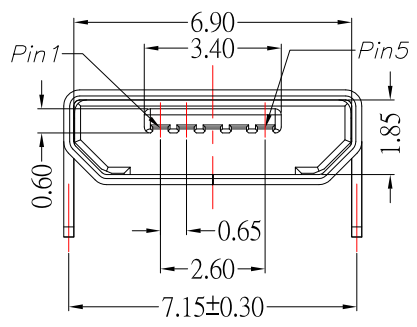
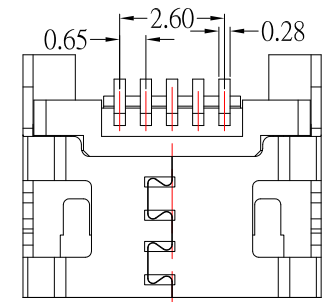
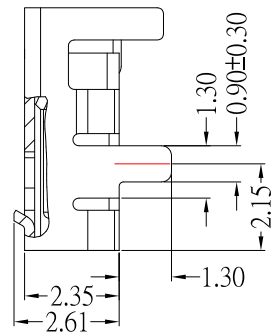
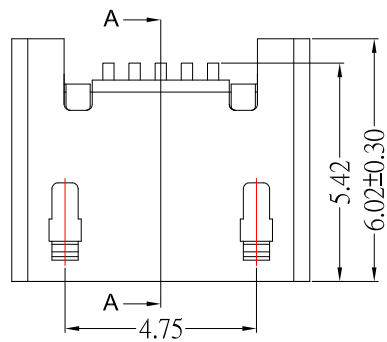

NOTES:

- 1.MATERIAL:
  - 1.1 HOUSING: LCP,UL94V-0
  - 1.2 CONTACT: PHOSPHOR BRONZE
  - 1.3 SHELL: BRASS / SUS
- 2.Finish:
  - 2.1 Contact: Plated Gold in Mating Area ;  
Gold Plated on Solder Balls ;  
Nickel under plated overall
  - 2.2 SHELL: NICKEL or TIN UNDER PLATED SURFACE LAYER
- 3.SPECIFICATION:
  - 3.1 CURRENT RATING: 1.8 A Max(PIN1,5)  
1.0 A Max(PIN2,3,4)
  - 3.2 DIELECTRIC WITHSTANDING VOLTAGE: 100 V(ac) FOR 1min
  - 3.3 CONTACT RESISTANCE: 30 mΩ MAX.
  - 3.4 INSULATION RESISTANCE: 100 MΩ MIN.
  - 3.5 TOTAL MATING FORCE: 3.57 Kgf MAX.
  - 3.6 TOTAL UNMATING FORCE: 1.0 Kgf MIN.
  - 3.7 TEMPERATURE RANGE: -30°C ~ +80°C

|          |             |       |        |
|----------|-------------|-------|--------|
| 4        | 更新樣式        | Jack  | 021420 |
| 3        | 更新尺寸        | Jack  | 031119 |
| 2        | 更新為A0版      | Jack  | 052217 |
| 1        | 新增材質選項      | Jack  | 051117 |
| ITEM NO. | DESCRIPTION | DRAWN | DATE   |

**CONTACT** 建倚科技股份有限公司  
**CONTACT TECHNOLOGY CORP.**

TOLERANCE UNLESS OTHERWISE STATED :  
 Up to 5 ±0.2  
 Above 5 ~ 15 ±0.3  
 Above 15 ~ 30 ±0.4  
 Above 30 ~ 50 ±0.5  
 Angle ±0.3

3RD. ANGEL'S

UNITS MM

|              |          |           |          |                                    |
|--------------|----------|-----------|----------|------------------------------------|
| DRAWN BY:    | DATE     | MAT'L     | TITLE    | CONNECTOR                          |
| Jack Lu      | 02/14/20 | FINISH    | MODLE    | MICRO USB 5BF 無捲邊 SHELLED DIP TYPE |
| CHECKED BY:  | DATE     | SCALE     | DWG NO.  | MRUSB-5B-D17xx-S347                |
| Jacky Chen   | 02/14/20 | SHEET NO. | PART NO. | MRUSB-5B-D17xx-S347                |
| APPROVED BY: | DATE     |           |          |                                    |
| Tony Kao     | 02/14/20 |           |          |                                    |