

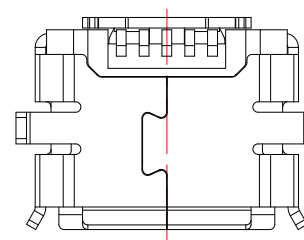

MRUSB-5B-D11x-S267

SHELL 鍍層:

TN
NI

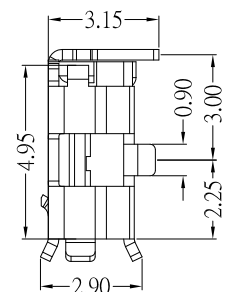
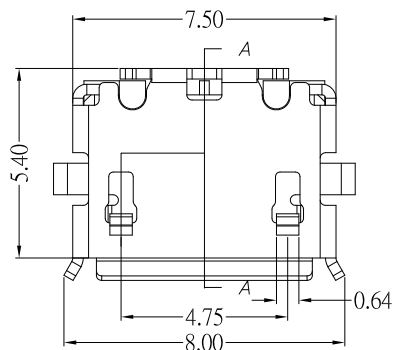
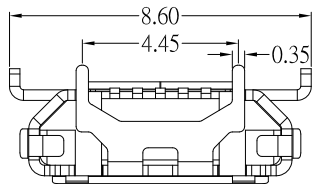

NOTES:

- MATERIAL:
 - HOUSING: LCP,UL94V-0
 - CONTACT: PHOSPHOR BRONZE
 - SHELL: BRASS
- Finish:
 - Contact: Plated Gold in Mating Area ;
Gold Plated on Solder Balls ;
Nickel under plated overall
 - SHELL: NICKEL or TIN UNDER PLATED SURFACE LAYER
- SPECIFICATION:
 - CURRENT RATING: PIN1,5--- 1.2 A Max
PIN2,3,4--- 1.0 A Max
 - DIELECTRIC WITHSTANDING VOLTAGE: 100 V(ac) FOR 1min
 - CONTACT RESISTANCE: 30 mΩ MAX.
 - INSULATION RESISTANCE: 100 MΩ MIN.
 - TOTAL MATING FORCE: 3.57 Kgf MAX.
 - TOTAL UNMATING FORCE: 1.0 Kgf MIN.
 - LIFE: 10,000 CYCLES
 - TEMPERATURE RANGE: -30°C ~ +80°C

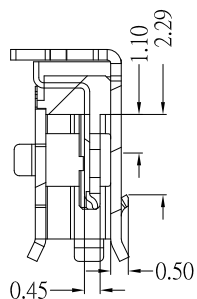

SECTION A-A

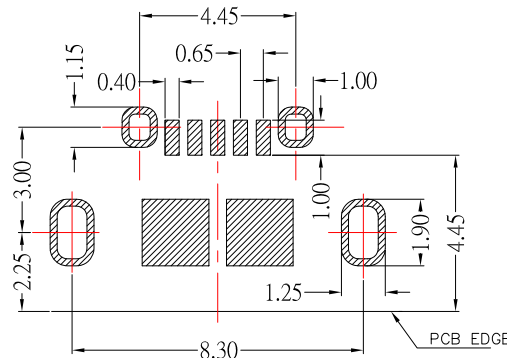
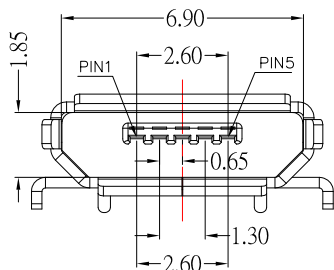
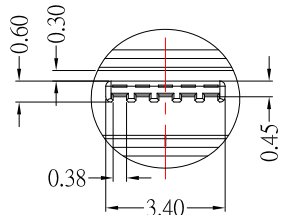

P.C.B LAYOUT MOUNTING PATTERN

CONTACT 建倚科技股份有限公司
CONTACT TECHNOLOGY CORP.

TOLERANCE UNLESS OTHERWISE STATED:
 Up to 5 ±0.2
 Above 5 ~ 15 ±0.3
 Above 15 ~ 30 ±0.4
 Above 30 ~ 50 ±0.5
 Angle ±0.3

3RD. ANGEL'S



UNITS MM

DRAWN BY:	DATE	MAT'L	TITLE	CONNECTOR
Jack Lu	02/10/15			
CHECKED BY:	DATE	FINISH	MODLE	MICRO USB 5S B TYPE 牛角型
Jacky Chen	02/10/15			PH: 4.45- 8.6mm
APPROVED BY:	DATE	SCALE	DWG NO.	MRUSB-5B-D11x-S267
Tony Kao	02/10/15	1 : 1	PART NO.	MRUSB-5B-D11x-S267
		SHEET NO.	1 of 1	
				SIZE A4
				VER A0