

SBC-160S21-20x-S175

鍍層厚度:

Blank : 1u"
2 : 15u"
3 : 30u"

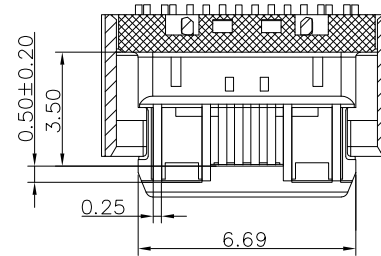
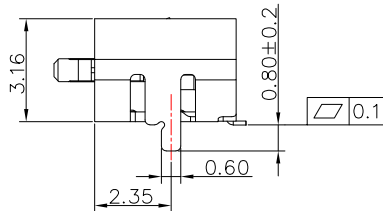
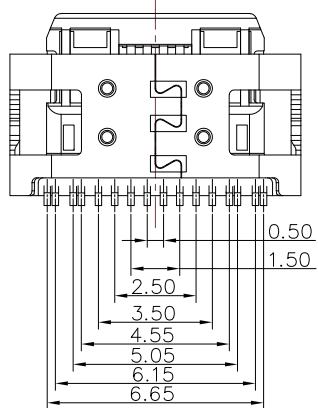
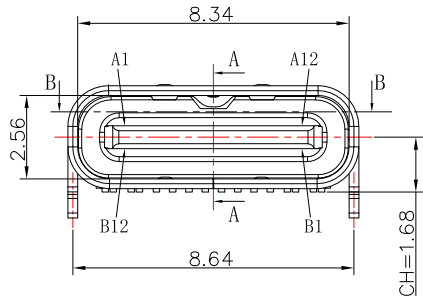
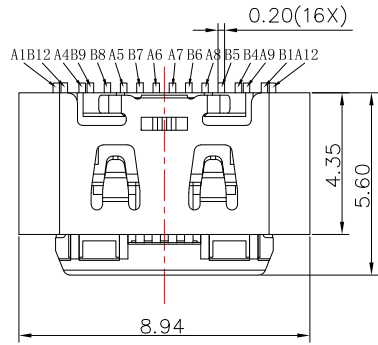

SECTION B-B
SCALE 1:1

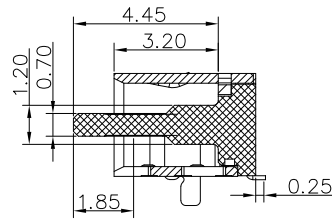

SECTION A-A
SCALE 1:1

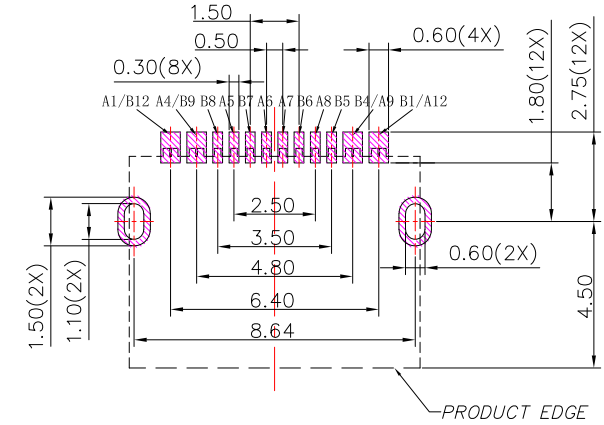

P.C.B. LAYOUT

USB TYPE C PIN ASSIGNMENTS

PIN NUMBER	SIGNAL NAME	PIN NUMBER	SIGNAL NAME
A1	GND	B12	GND
A4	VBUS	B9	VBUS
A5	CC1	B8	SUB2
A6	Dp1	B7	Dn2
A7	Dn1	B6	Dp2
A8	SBU1	B5	CC2
A9	VBUS	B4	VBUS
A12	GND	B1	GND

SPECIFICATIONS

Electrical:

- Rating: 5.0 V , 5.0 A
- Dielectric Withstand Voltage: 100V AC
- Contact Resistance: 40 mΩ Max
- Insulation Resistance: 100 MΩ Min

Mechanical:

- Connector Mate and Unmate Force
 - Mate force: 5~20 N
 - Unmate force: 8~20 N

Material:

- Housing: PA9T
- Contact: C18400
- Shell: SUS

Finish:

- Contact: Plated Gold in Mating Area ;
Gold Plated on Solder Balls ;
Nickel under plated overall
- Shell: Nickel under Plated surface layer