

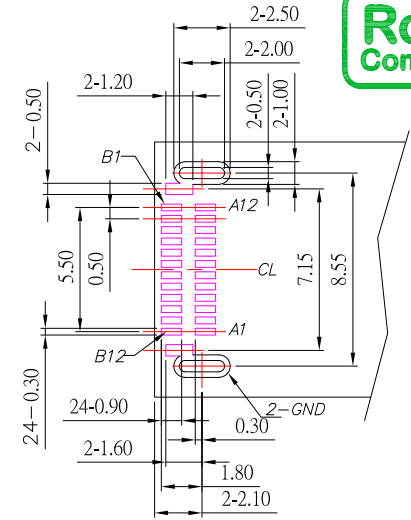

# SBC-241PLM8-43x-S242

鍍層厚度：

Blank	: 1u"
2	: 15u"
3	: 30u"

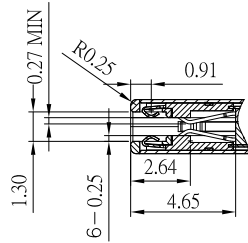
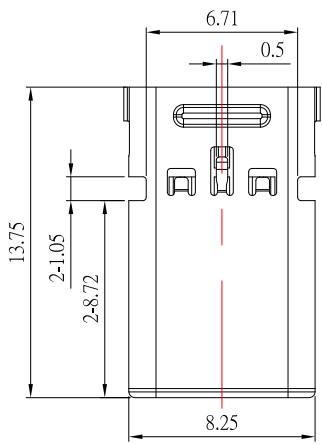

## P.C.B LAYOUT

### SPECIFICATIONS

#### Electrical:

1. Rating: 3.0A
2. Dielectric Withstand Voltage: 100V AC
3. Contact Resistance: 40 mΩ Max
4. Insulation Resistance: 100 MΩ Min

#### Material:

1. Housing: LCP
2. Contact: C7025
3. Shell: SUS

#### Finish:

1. Contact: Plated Gold in Mating Area ;  
Tin Plated on Solder Balls ;  
Nickel under plated overall
2. Shell: Nickel under Plated surface layer

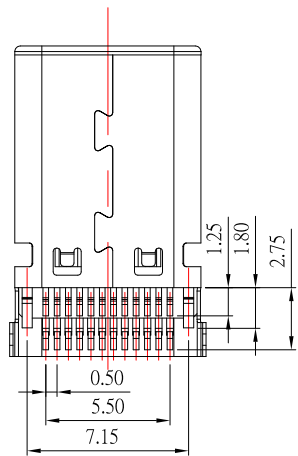
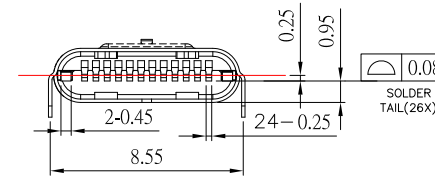
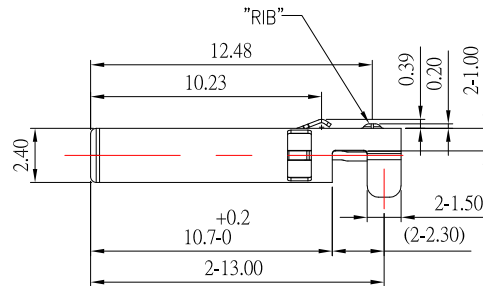
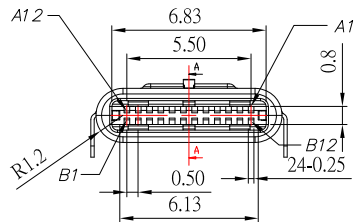

Pin Number		Pin Number	
PIN A1	GND	PIN B12	GND
PIN A2	TX1+	PIN B11	RX1+
PIN A3	TX1-	PIN B10	RX1-
PIN A4	VBUS	PIN B9	VBUS
PIN A5	CC	PIN B8	SBU2
PIN A6	D+	PIN B7	D-
PIN A7	D-	PIN B6	D+
PIN A8	SBU1	PIN B5	VCONN
PIN A9	VBUS	PIN B4	VBUS
PIN A10	RX2-	PIN B3	TX2-
PIN A11	RX2+	PIN B2	TX2+
PIN A12	GND	PIN B1	GND



TOLERANCE UNLESS OTHERWISE STATED :	Up to 5 ±0.2	Above 5 ~ 15 ±0.3	Above 15 ~ 30 ±0.4	Above 30 ~ 50 ±0.5	Angle ±0.3	3RD. ANGEL'S	UNITS	MM
-------------------------------------	--------------	-------------------	--------------------	--------------------	------------	--------------	-------	----

DRAWN BY:	DATE	MATL	TITLE	CONNECTOR
Jack Lu	10/08/24			
CHECKED BY:	DATE	FINISH	MODLE	USB TYPE C Male USB4 GEN2 20G 沉板 端子SMT 外殼DIP TYPE
Jacky Chen	10/08/24			
APPROVED BY:	DATE	SCALE	DWG NO.	SBC-241PLM8-43x-S242
Tony Kao	10/08/24	1 : 1		
		SHEET NO.	PART NO.	SBC-241PLM8-43x-S242
		1 of 1		
				SIZE A4
				VER R1

1	更新料號	Jack	100824
ITEM NO.	DESCRIPTION	DRAWN	DATE