

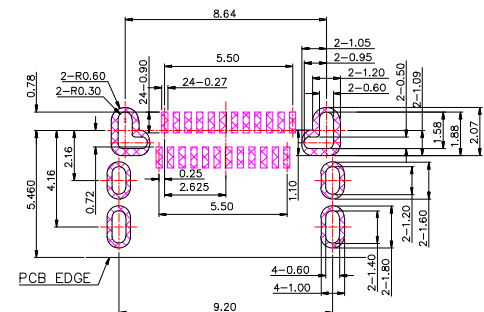

SBC-240S33-43x-S461

鍍層厚度：
 Blank : 1u"
 2 : 15u"
 3 : 30u"

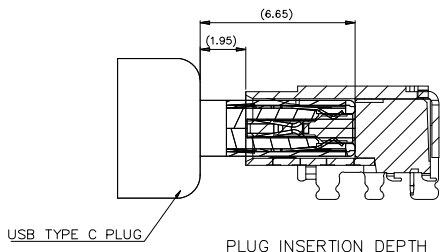
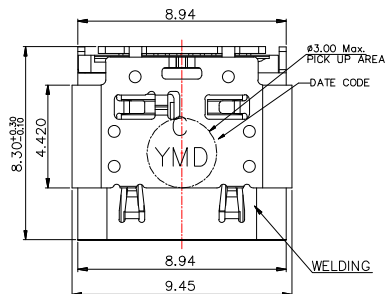

P.C.B LAYOUT

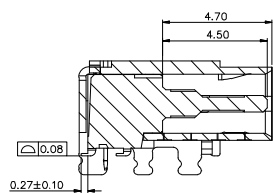
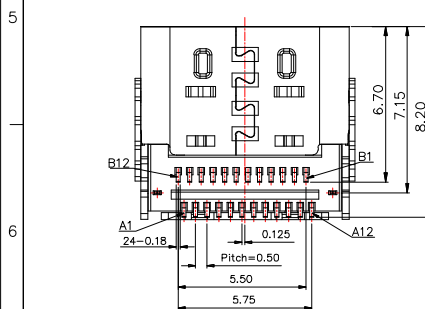
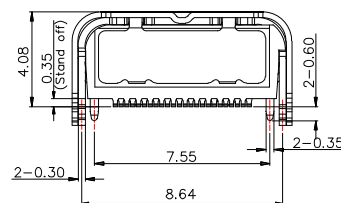
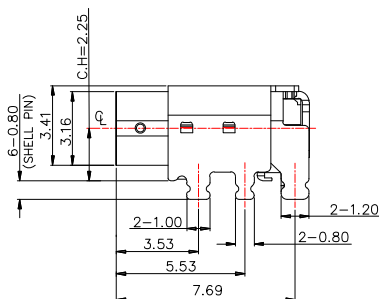
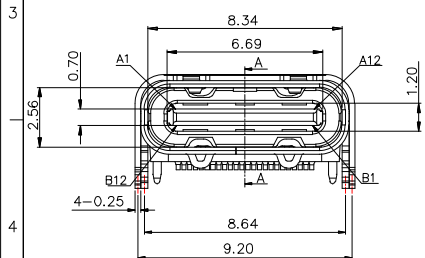

SECTION A-A

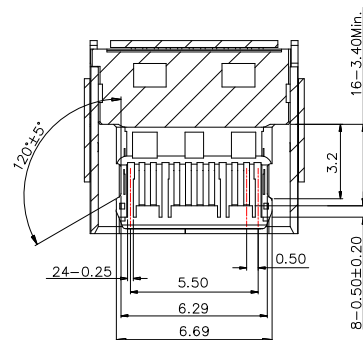

SECTION B-B

USB TYPE-C PIN ASSIGNMENTS:

PIN	SIGNAL NAME	PIN	SIGNAL NAME
A12	GND	B1	GND
A11	SSRXp2	B2	SSTXp2
A10	SSRXn2	B3	SSTXn2
A9	vBUS	B4	vBUS
A8	SBU1	B5	CC2
A7	Dn1	B6	Dp2
A6	Dp1	B7	Dn2
A5	CC1	B8	SBU2
A4	vBUS	B9	vBUS
A3	SSTXn1	B10	SSRXn1
A2	SSTXp1	B11	SSRXp1
A1	GND	B12	GND

SPECIFICATIONS

Electrical:

- Rating: 20V ; 5.0A
- Contact Resistance: 40 mΩ Max
- Insulation Resistance: 100 MΩ Min
- Dielectric Withstanding Voltage: 100V AC

Mechanical:

- Connector Mate and Unmate Force
 - Mate force: 5~20 N
 - Unmate force: 8~20 N

Material:

- Housing: PA9T
- Contact: C19400
- Shell: SUS

Finish:

- Contact: Plated Gold in Mating Area ;
Gold Plated on Solder Balls ;
Nickel under plated overall
- Shell: Nickel under Plated surface layer



TOLERANCE UNLESS OTHERWISE STATED:
 Up to 5 ±0.2
 Above 5 ~ 15 ±0.3
 Above 15 ~ 30 ±0.4
 Above 30 ~ 50 ±0.5
 Angle ±0.3

3RD. ANGEL'S



UNITS MM

DRAWN BY:	DATE	MAT'L	TITLE	CONNECTOR
Jack Lu	12/07/23		MODLE	USB 4.0 Gen3 TYPE C 母座板上 L8.3 雙殼 板上墊高 CL 2.25mm
CHECKED BY:	DATE	FINISH	DWG NO.	SBC-240S33-43x-S461
Jacky Chen	12/07/23		PART NO.	SBC-240S33-43x-S461
APPROVED BY:	DATE	SCALE	SHEET NO.	1 of 1
Tony Kao	12/07/23	1 : 1	SIZE	A4
			VER	R

ITEM NO.	DESCRIPTION	DRAWN	DATE
1	新增PCB LAYOUT尺寸	Jack	112421