

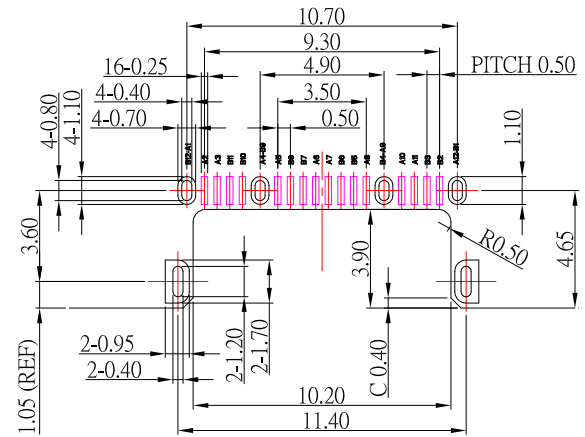

SBC-WP240M-45x-S382

鍍層厚度：

Blank : 1u"
2 : 15u"
3 : 30u"

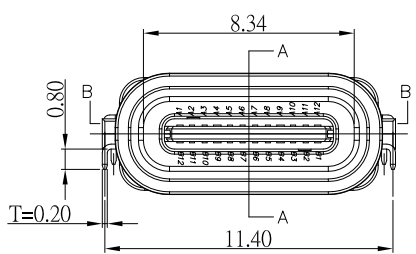
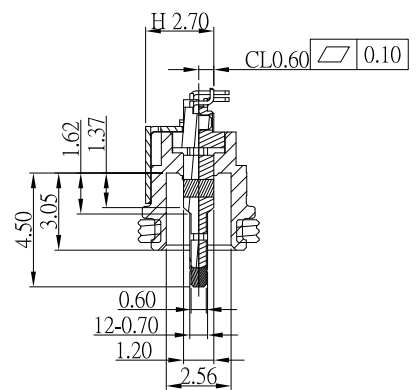
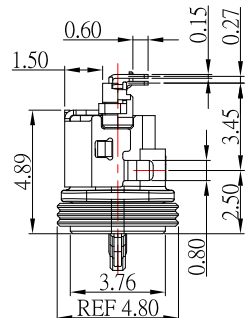
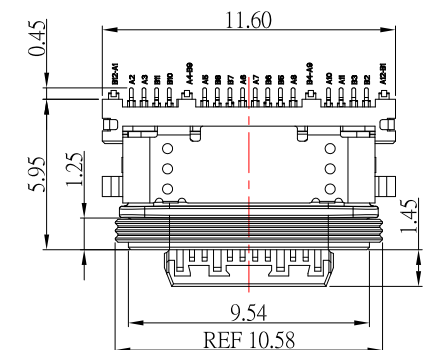

RECOMMEND P.C.B LAYOUT (COMPONENT SIDE)

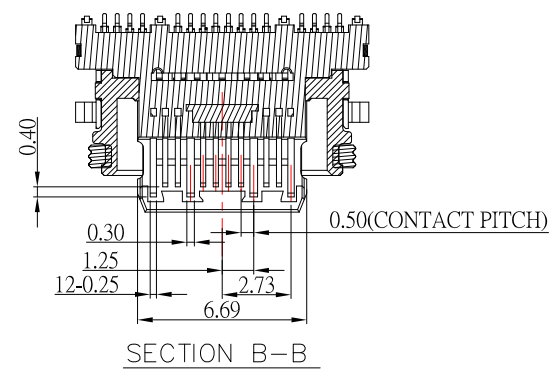
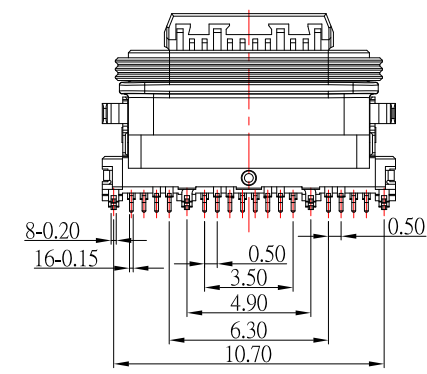

SPECIFICATIONS

- Electrical:**
- Rating: 5.0A
 - Contact Resistance: 40 mΩ Max
 - Insulation Resistance: 100 MΩ Min
 - Dielectric Withstanding Voltage: 100V AC

- Mechanical:**
- Connector Mate and Unmate Force
 - Mate force: 5~20 N
 - Unmate force: 8~20 N

- Material:**
- Housing: PA9T
 - Contact: C18400
 - Shell: SUS

- Finish:**
- Contact: Plated Gold in Mating Area ;
Tin Plated on Solder Balls ;
Nickel under plated overall
 - Shell: Nickel under Plated surface layer

Pin	Signal Name	Mating Sequence	Pin	Signal Name	Mating Sequence
A1	GND	First	B12	GND	First
A2	SSTXp1	Second	B11	SSRXp1	Second
A3	SSTXn1	Second	B10	SSRXn1	Second
A4	V _{BUS}	First	B9	V _{BUS}	First
A5	CC1	Second	B8	SBU2	Second
A6	Dp1	Second	B7	Dn2	Second
A7	Dn1	Second	B6	Dp2	Second
A8	SBU1	Second	B5	CC2	Second
A9	V _{BUS}	First	B4	V _{BUS}	First
A10	SSRXn2	Second	B3	SSTXn2	Second
A11	SSRXp2	Second	B2	SSTXp2	Second
A12	GND	First	B1	GND	First
SHELL	GND		SHELL	GND	

CONTACT 建倚科技股份有限公司
CONTACT TECHNOLOGY CORP.

TOLERANCE UNLESS OTHERWISE STATED:
 Up to 5 ±0.2
 Above 5 ~ 15 ±0.3
 Above 15 ~ 30 ±0.4
 Above 30 ~ 50 ±0.5
 Angle ±0.3°

3RD. ANGEL'S



UNITS MM

DRAWN BY:	DATE	MAT'L	TITLE	CONNECTOR
Jack Lu	12/23/22			
CHECKED BY:	DATE	FINISH	MODLE	USB4 CF WATERPROOF CL=0.60 MID-MOUNT
Jacky Chen	12/23/22			
APPROVED BY:	DATE	SCALE	DWG NO.	SBC-WP240M-45x-S382
Tony Kao	12/23/22	1 : 1	PART NO.	SBC-WP240M-45x-S382
		SHEET NO.	1 of 2	SIZE A4
				VER R2

ITEM NO.	DESCRIPTION	DRAWN	DATE
2	更新MODLE	Jack	122322
1	更新Contact材質	Jack	102122

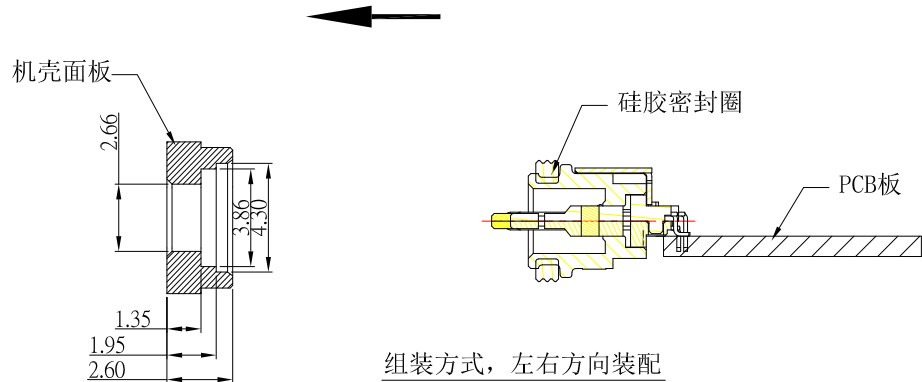

组装方式，左右方向装配

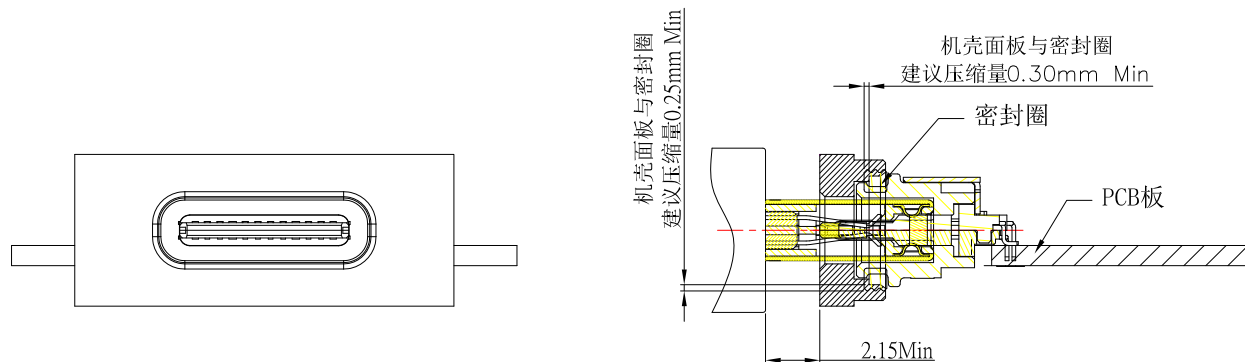

组装面板后公母头对插示意图

CONTACT 建倚科技股份有限公司
CONTACT TECHNOLOGY CORP.

TOLERANCE UNLESS OTHERWISE STATED:
Up to 5 ±0.2
Above 5 ~ 15 ±0.3
Above 15 ~ 30 ±0.4
Above 30 ~ 50 ±0.5
Angle ±0.3°

3RD. ANGEL'S



UNITS

MM

DRAWN BY:	DATE	MATL	TITLE	CONNECTOR
Jack Lu	12/23/22		MODLE	USB4 CF WATERPROOF CL=0.60 MID-MOUNT
CHECKED BY:	DATE	SCALE	DWG NO.	SBC-WP240M-45x-S382
Jacky Chen	12/23/22	1 : 1	PART NO.	SBC-WP240M-45x-S382
APPROVED BY:	DATE	SHEET NO.	2 of 2	
Tony Kao	12/23/22			

2	更新MODLE	Jack	122322
1	更新Contact材質	Jack	102122
ITEM NO.	DESCRIPTION	DRAWN	DATE