

SECTION A-A
SCALE 2:1

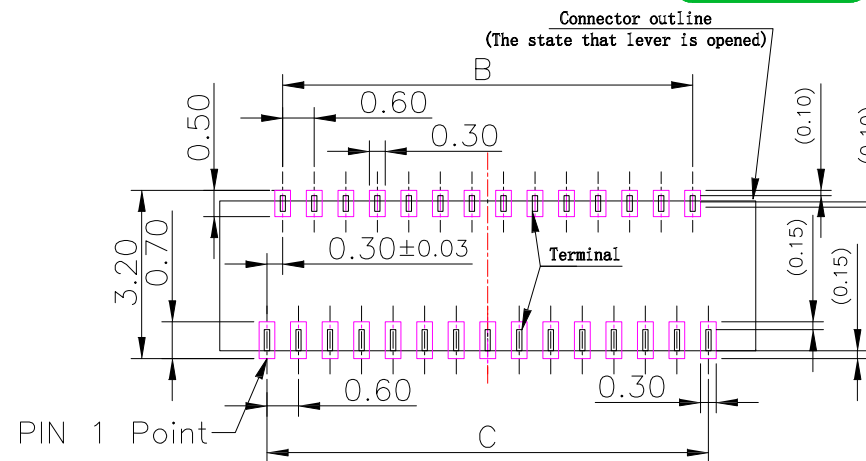

RECOMMENDED PCB LAYOUT

1.35(Suction area)

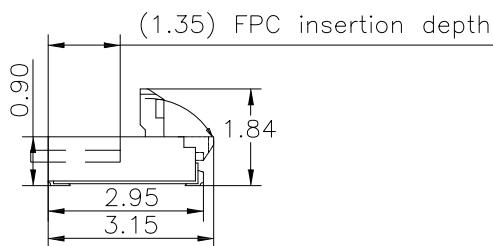
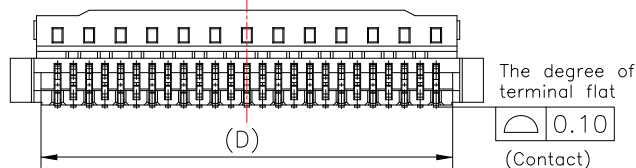

SPECIFICATIONS

Electrical Characteristics:

- 1.1 Current rating: 0.2A
- 1.2 Voltage rating: 50V
- 1.3 Operating Temperature range: -55°C ~ +85°C

Material:

- 1.1 Housing: LCP
- 1.2 Cover: HTN
- 1.3 Contact: Phosphor Bronze

Finish:

- 1.1 Contact: Plated Gold in Mating Area ;
Gold Plated on Solder Balls
Nickel under plated overall

PIN NO.	DIM A	DIM B	DIM C	DIM D
09	4.20	1.80	2.40	3.03
23	8.40	6.00	6.60	7.23
25	9.00	6.60	7.20	7.83
27	9.60	7.20	7.80	8.43
31	10.80	8.40	9.00	9.63
39	13.20	10.80	11.40	12.03

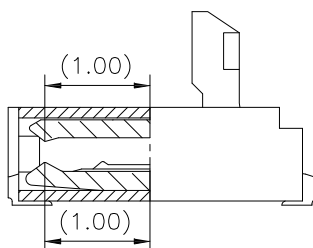

SECTION B-B
SCALE 2:1

CONTACT 建倚科技股份有限公司
CONTACT TECHNOLOGY CORP.

TOLERANCE UNLESS OTHERWISE STATED :
Up to 5 ±0.2
Above 5 ~ 15 ±0.3
Above 15 ~ 30 ±0.4
Above 30 ~ 50 ±0.5
Angle ±0.3

3RD. ANGEL'S



UNITS

MM

DRAWN BY:	DATE	MAT'L	TITLE	CONNECTOR
Jack Lu	08/15/23			
CHECKED BY:	DATE	FINISH	MODLE	0.3PH 0.9H FPC CONNECTOR BACK-FLIP TYPE
Jacky Chen	08/15/23			
APPROVED BY:	DATE	SCALE	DWG NO.	FPC03D-09xx-C6-S149
Tony Kao	08/15/23	1 : 1	PART NO.	FPC03D-09xx-C6-S149
		SHEET NO.	1 of 2	SIZE A4
				VER R1

ITEM NO.	DESCRIPTION	DRAWN	DATE
1	更新PIN數選項	Jack	081523

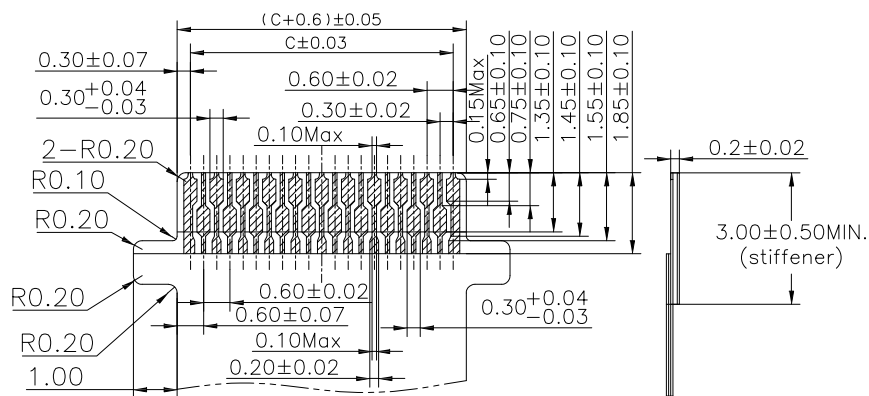

With insertion confirming tabs and lead platings

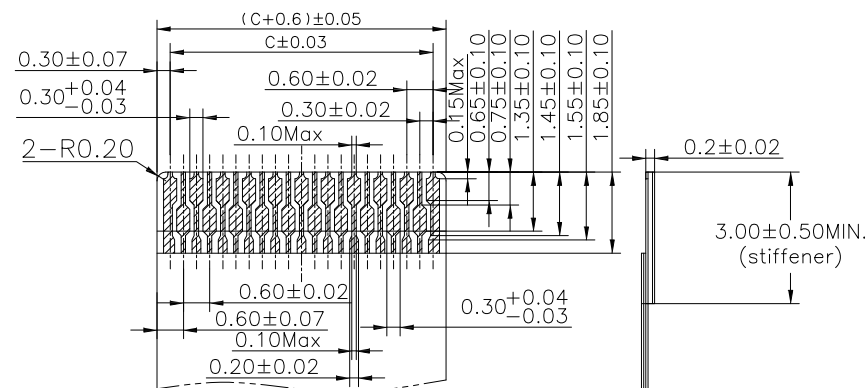

Without insertion confirming tabs and lead platings

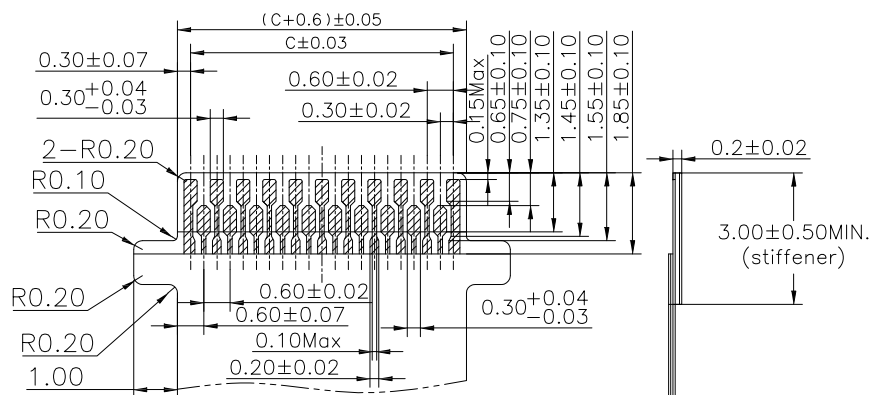

With insertion confirming tabs but lead platings

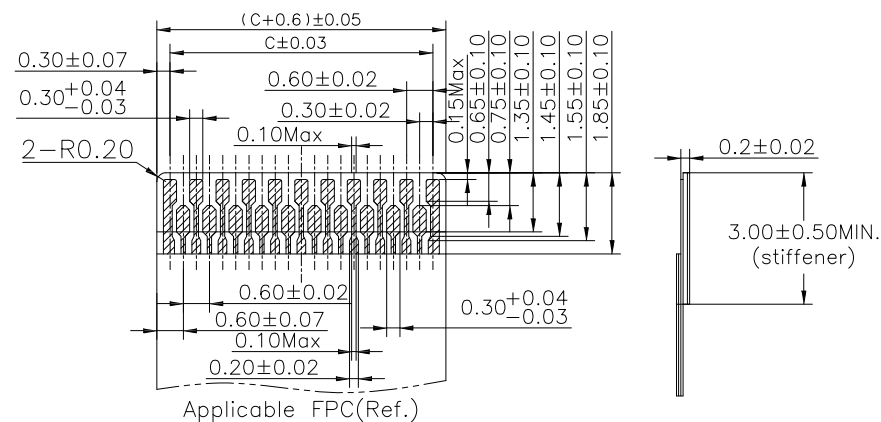

Without insertion confirming tabs but lead platings

CONTACT 建倚科技股份有限公司
CONTACT TECHNOLOGY CORP.

TOLERANCE UNLESS OTHERWISE STATED :
Up to 5 ±0.2
Above 5 ~ 15 ±0.3
Above 15 ~ 30 ±0.4
Above 30 ~ 50 ±0.5
Angle ±0.3

3RD. ANGEL'S



UNITS MM

DRAWN BY:	DATE	MAT'L	TITLE	CONNECTOR
Jack Lu	08/15/23			
CHECKED BY:	DATE	FINISH	MODLE	0.3PH 0.9H FPC CONNECTOR BACK-FLIP TYPE
Jacky Chen	08/15/23			
APPROVED BY:	DATE	SCALE	DWG NO.	FPC03D-09xx-C6-S149
Tony Kao	08/15/23	1 : 1	PART NO.	FPC03D-09xx-C6-S149
		SHEET NO.	2 of 2	SIZE A4
				VER R1

1	更新PIN數選項	Jack	081523
ITEM NO.	DESCRIPTION	DRAWN	DATE