

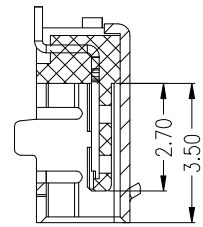

MRUSB-5B-D2Bx-S347

SHELL 鍍層:

TN
NI

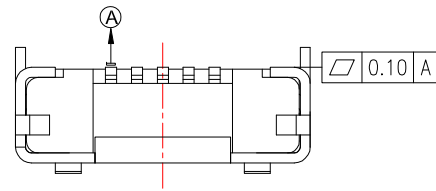

SECTION A-A'

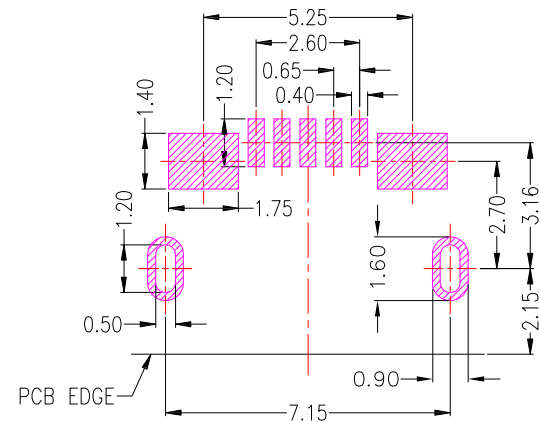
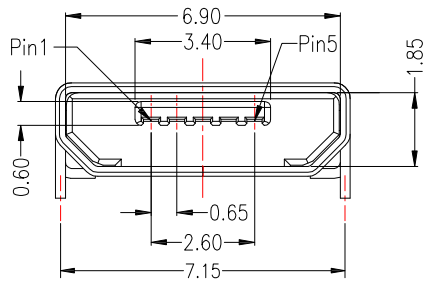
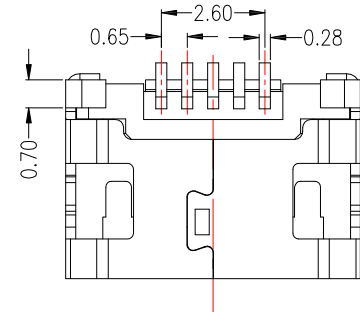
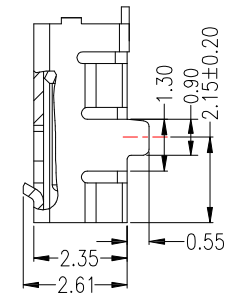
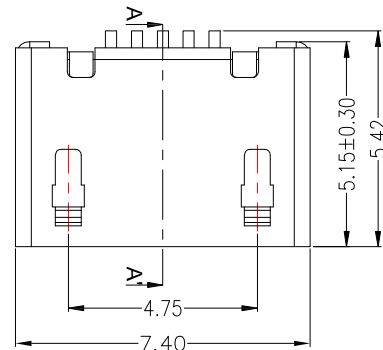

P.C.B LAYOUT MOUNTING PATTERN

NOTES:

MATERIAL:

- 1.1 HOUSING: LCP, UL94V-0, Black
- 1.2 CONTACT: PHOSPHOR BRONZE
- 1.3 SHELL: BRASS

FINISH:

- 2.1 CONTACT: PLATED GOLD IN MATING AREA ;
TIN PLATED ON SOLDER BALLS ;
NICKEL UNDER PLATED OVERALL
- 2.2 SHELL: NICKEL UNDER PLATED SURFACE LAYER OR
TIN UNDER PLATED SURFACE LAYER

3.SPECIFICATION:

- 3.1 RATING: 1.5A(PIN1&8), 1.0A(PIN2&3&4)
- 3.2 DIELECTRIC WITHSTANDING VOLTAGE: 100 VAC
- 3.3 CONTACT RESISTANCE: 30 mΩ MAX.
- 3.4 INSULATION RESISTANCE: 100 MΩ MIN.
- 3.5 TOTAL MATING FORCE: 3.57 Kgf MAX.
- 3.6 TOTAL UNMATING FORCE: 1.0 Kgf MIN.
- 3.7 TEMPERATURE RANGE: -30°C ~ +80°C

CONTACT 建倚科技股份有限公司
CONTACT TECHNOLOGY CORP.

TOLERANCE UNLESS OTHERWISE STATED:
 Up to 5 ±0.2
 Above 5 ~ 15 ±0.3
 Above 15 ~ 30 ±0.4
 Above 30 ~ 50 ±0.5
 Angle ±0.3°

3RD. ANGEL'S

UNITS MM

DRAWN BY: Jack Lu
 CHECKED BY: Jacky Chen
 APPROVED BY: Tony Kao

DATE: 01/16/19
 DATE: 01/16/19
 DATE: 01/16/19

MAT'L		TITLE	CONNECTOR
FINISH		MODLE	MICRO USB 5P/F 贴片 无捲边 无柱 前插(7.15)后贴
SCALE	1 : 1	DWG NO.	MRUSB-5B-D2Bx-S347
SHEET NO.	1 of 1	PART NO.	MRUSB-5B-D2Bx-S347
		SIZE	A4
		VER	R1

1	新增尺寸	Jack	011619
ITEM NO.	DESCRIPTION	DRAWN	DATE